

MODELS CSF & LSF

BELT DRIVE CENTRIFUGAL FILTERED SUPPLY FANS

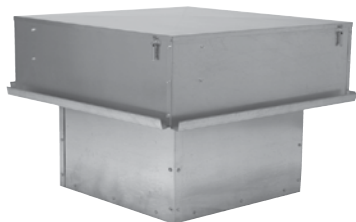

**Model CSF
Hooded Design**



**Model LSF
Louvered Penthouse Design**

MODEL FEATURES

- Supply air to over 13,000 CFM in static pressure capabilities to 2" w.g.
- Heavy-galvanized construction
- Belt drives permit easy performance adjustments when needed
- Forward curved centrifugal blower for efficient air flow at low sound levels
- Filters are washable and reusable
- AMCA Air and Sound Licensed
- cULus 705 Listed

MODEL OVERVIEW

Models CSF and LSF units are roof mounted, filtered supply fans rated from 375 to over 13,000 CFM, with static pressure capabilities to 2". Model CSF's rugged, heavy-gauge galvanized hood and stack provide maximum weather protection and long life. Model LSF's architecturally pleasing, heavy-gauge aluminum louver design provides long life and the utmost in performance efficiency. All models are belt driven for easier performance adjustment and quieter operation. Adjustable motor pulleys further simplify fan speed changes.

S&P's Centrifugal Filtered Supply Fans are used to replace exhausted fumes, vapors and gases with fresh, filtered make-up air in commercial and industrial applications such as manufacturing and assembly areas, kitchens, athletic clubs and many others.

CONSTRUCTION FEATURES AND OPTIONS

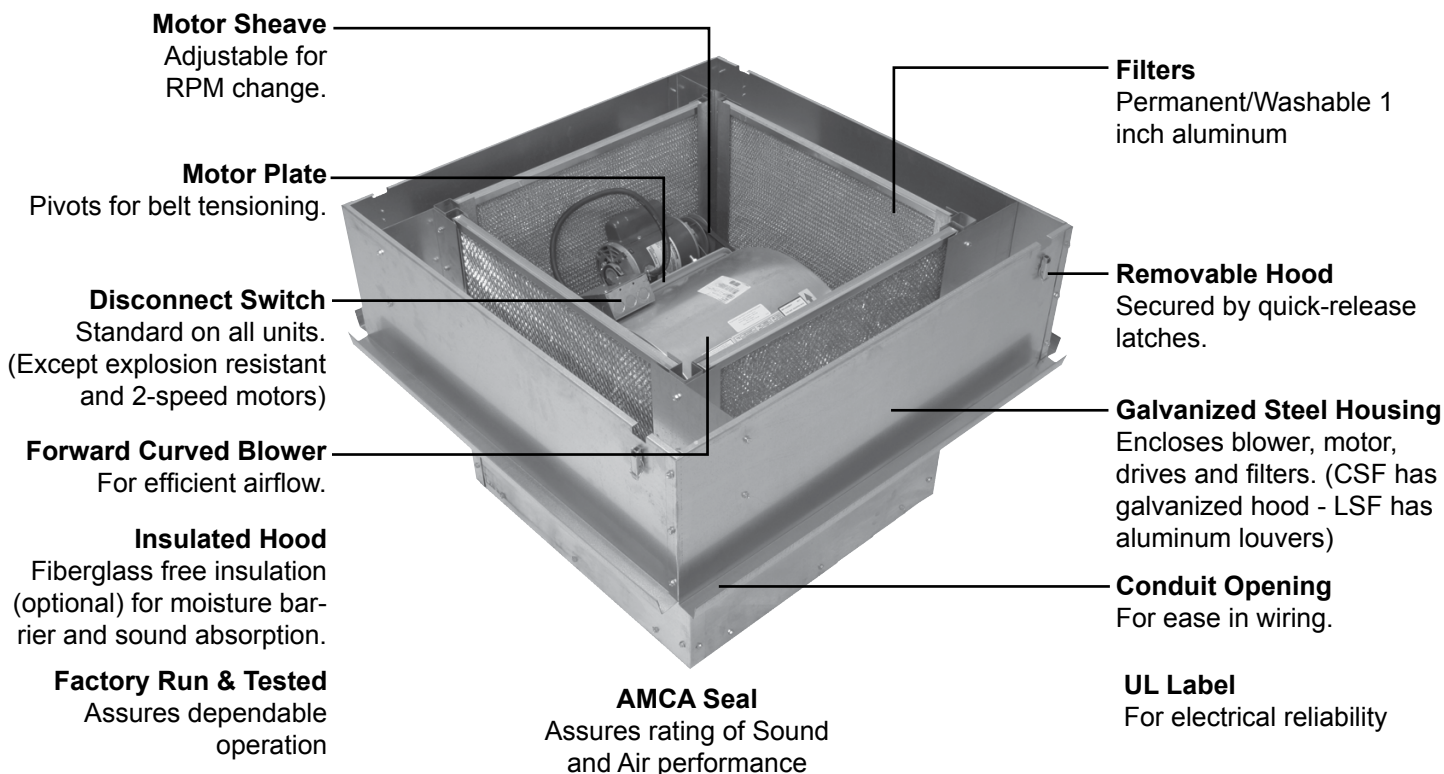

Industry best 5 year fan housing warranty, 1 year motor warranty

All specifications are subject to change without notice unless approved in submittal by Soler & Palau.
CGV_CSF-LSF_0612

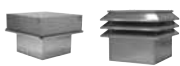

CONSTRUCTION/SPECIFICATION CHECKLIST

Blower/Housing

- Statically and dynamically balanced forward curved wheel.
- 12-gauge galvanized steel blower plate/discharge opening.
- Heavy-gauge galvanized steel housing.
- Prepunched mounting holes.
- Conduit opening for wiring from below unit.

Hooded/Louvered Top

- Heavy-gauge aluminum louvered design. (LSF)
- Heavy-gauge galvanized steel hood. (CSF)
- Quick-release latches for removal from housing.
- Insulated for sound absorption and moisture barrier.
- Oversized for weather protection.
- 1" washable aluminum mesh filters.
- Mitered cut and welded corners. (LSF)

Drives

- Adjustable motor pulleys are standard.
- Sized for minimum 150% of drive horsepower.
- Pivoting motor plate for belt tensioning.
- Non-static oil resistant V-belts.

Bearings

- Five year warranty.
- Heavy-duty ball bearing type.
- Prelubricated and permanently sealed.

Motors

- One year warranty.
- Brands are nationally recognized and locally serviced.
- Open drip-proof construction is standard.
- Disconnect switch standard with single speed drip-proof and totally enclosed motors.
- Optional motor enclosures and types can be specified.

Certifications

- AMCA Air and Sound Licensed.
- cULus Standard 705 Listed Power Roof Ventilator label assures electrical reliability.
- cULus label must be specified when needed.

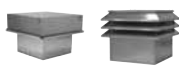

OPTIONS/ACCESSORIES

Roof Curb: Prefabricated heavy-gauge galvanized steel, Clip Lock, 14" high with 1-1/2" wood nailer. Options include burglar bars, single and double pitch construction, and additional curb heights.

Motor Operated Damper: Motor operated aluminum damper for positive closure against backdraft (counter balanced).



Automatic Damper: Automatic aluminum damper for ease in installation and effective backdraft protection (counter balanced).

Duct Adaptor: For ease in connecting discharge duct to fan outlet.

Side Discharge: For convenient connection to a supply duct when mounted on roof where the inside ceiling height is limited (CSF). Not available on CSF9.

Special Coatings: For protective and decorative purposes. Available coatings include: Epoxy, Synthetic Resin, and Heresite (air-dried phenolic). Contact your Soler & Palau representative or the factory for more information on available coatings and colors.

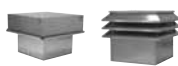

CSF PERFORMANCE

CSF 9

MODEL CSF	CFM	OV		Static Pressure in Inches w.g.						
				1/8	1/4	3/8	1/2	5/8	3/4	1
475	540	RPM	440	-	-	-	-	-	-	-
		BHP	0.03	-	-	-	-	-	-	-
		Sones	12.3	-	-	-	-	-	-	-
575	653	RPM	445	-	-	-	-	-	-	-
		BHP	0.04	-	-	-	-	-	-	-
		Sones	12.3	-	-	-	-	-	-	-
675	767	RPM	461	622	-	-	-	-	-	-
		BHP	0.05	0.09	-	-	-	-	-	-
		Sones	12.6	15.4	-	-	-	-	-	-
775	881	RPM	485	625	-	-	-	-	-	-
		BHP	0.07	0.1	-	-	-	-	-	-
		Sones	13.1	15.5	-	-	-	-	-	-
875	994	RPM	512	637	762	-	-	-	-	-
		BHP	0.08	0.12	0.18	-	-	-	-	-
		Sones	13.5	15.8	18.2	-	-	-	-	-
975	1108	RPM	544	656	768	880	-	-	-	-
		BHP	0.11	0.15	0.2	0.26	-	-	-	-
		Sones	13.9	16.3	18.3	21	-	-	-	-
1075	1222	RPM	578	680	781	883	984	-	-	-
		BHP	0.13	0.18	0.23	0.29	0.36	-	-	-
		Sones	14.3	16.9	18.7	21	23	-	-	-
1175	1335	RPM	613	706	800	892	986	-	-	-
		BHP	0.17	0.21	0.26	0.33	0.39	-	-	-
		Sones	14.9	17.6	19.3	21	23	-	-	-
1275	1449	RPM	650	735	823	907	993	1079	-	-
		BHP	0.2	0.25	0.31	0.37	0.44	0.51	-	-
		Sones	15.8	18.2	20	22	24	25	-	-
1375	1563	RPM	687	768	847	927	1006	1086	1244	-
		BHP	0.25	0.3	0.35	0.42	0.49	0.56	0.73	-
		Sones	16.8	19.1	21	22	24	26	30	-
1475	1676	RPM	726	801	875	951	1023	1097	1247	-
		BHP	0.29	0.35	0.41	0.47	0.54	0.62	0.79	-
		Sones	17.8	19.8	22	23	25	26	30	-
1575	1790	RPM	765	836	905	975	1045	1113	1253	-
		BHP	0.35	0.41	0.47	0.54	0.61	0.68	0.86	-
		Sones	19.2	21	23	24	25	27	30	-
1675	1903	RPM	804	872	937	1002	1069	1134	1263	-
		BHP	0.41	0.48	0.54	0.61	0.68	0.76	0.93	-
		Sones	20	22	24	25	26	27	31	-
1775	2017	RPM	844	908	970	1031	1093	1157	1278	-
		BHP	0.48	0.55	0.62	0.69	0.76	0.84	1.01	-
		Sones	22	23	24	26	27	28	32	-
1875	2131	RPM	884	946	1005	1063	1120	1181	-	-
		BHP	0.56	0.63	0.7	0.78	0.85	0.93	-	-
		Sones	23	24	26	27	28	29	-	-
1975	2244	RPM	925	984	1040	1095	1150	1205	-	-
		BHP	0.65	0.72	0.8	0.87	0.95	1.03	-	-
		Sones	25	26	27	28	29	30	-	-
2075	2358	RPM	966	1022	1076	1129	1181	-	-	-
		BHP	0.74	0.82	0.9	0.98	1.06	-	-	-
		Sones	26	27	28	29	30	-	-	-
2175	2472	RPM	1007	1061	1113	1163	-	-	-	-
		BHP	0.85	0.93	1.01	1.09	-	-	-	-
		Sones	27	29	29	30	-	-	-	-
2275	2585	RPM	1048	1100	-	-	-	-	-	-
		BHP	0.96	1.05	-	-	-	-	-	-
		Sones	29	30	-	-	-	-	-	-
2375	2699	RPM	1089	-	-	-	-	-	-	-
		BHP	1.09	-	-	-	-	-	-	-
		Sones	30	-	-	-	-	-	-	-

9



S&P Canada Ventilation Products, Inc., Div. of Soler & Palau Ventilation Group, certifies that the Model CSF shown herein are licensed to bear the AMCA Seal. The ratings shown are based on test and procedures performed in accordance with AMCA Publication 211 and AMCA Publication 311 and comply with the requirement of the AMCA Certified Ratings Program.



Performance certified is for installation type B: free inlet, ducted outlet. Power rating (BHP) does not include transmission losses. Performance ratings do not include the effects of appurtenances (accessories). The sound ratings shown are loudness values in fan sones at a distance of 1.5 m (5 ft) in a hemispherical free field calculated per AMCA International Standard 301. Values shown are for installation type B: ducted outlet hemispherical sone levels. Ratings do not include the effect of duct end correction.

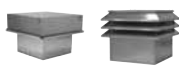

CSF 10

MODEL CSF	CFM	OV		Static Pressure in Inches w.g.											
				1/8	1/4	3/8	1/2	5/8	3/4	1	1-1/4	1-1/2	2		
10	700	654	RPM	377	516	-	-	-	-	-	-	-	-	-	-
			BHP	0.04	0.07	-	-	-	-	-	-	-	-	-	-
			Sones	3.3	5.8	-	-	-	-	-	-	-	-	-	-
	825	771	RPM	393	521	-	-	-	-	-	-	-	-	-	-
			BHP	0.05	0.09	-	-	-	-	-	-	-	-	-	-
			Sones	3.9	5.9	-	-	-	-	-	-	-	-	-	-
	950	888	RPM	412	530	635	-	-	-	-	-	-	-	-	-
			BHP	0.07	0.1	0.14	-	-	-	-	-	-	-	-	-
			Sones	4.7	6.3	9.2	-	-	-	-	-	-	-	-	-
	1075	1005	RPM	436	543	642	733	-	-	-	-	-	-	-	-
			BHP	0.09	0.13	0.17	0.22	-	-	-	-	-	-	-	-
			Sones	5.7	7.1	9.6	12.6	-	-	-	-	-	-	-	-
	1200	1121	RPM	462	560	652	739	819	-	-	-	-	-	-	-
			BHP	0.11	0.15	0.2	0.25	0.3	-	-	-	-	-	-	-
			Sones	6.8	7.8	10.1	12.9	15.1	-	-	-	-	-	-	-
	1325	1238	RPM	491	580	666	748	825	898	-	-	-	-	-	-
			BHP	0.14	0.18	0.23	0.29	0.34	0.4	-	-	-	-	-	-
			Sones	7.9	8.7	11.1	13.3	15.3	17.5	-	-	-	-	-	-
	1450	1355	RPM	521	603	683	760	833	904	1034	-	-	-	-	-
			BHP	0.17	0.22	0.27	0.33	0.39	0.45	0.58	-	-	-	-	-
			Sones	9.3	9.8	11.9	13.9	15.8	17.8	22	-	-	-	-	-
	1575	1472	RPM	552	628	702	774	844	912	1039	1155	-	-	-	-
			BHP	0.21	0.26	0.32	0.38	0.44	0.5	0.64	0.79	-	-	-	-
			Sones	10.7	11.2	13.2	14.7	16.4	18.2	22	27	-	-	-	-
	1700	1589	RPM	584	655	724	792	858	923	1045	1159	1264	-	-	-
			BHP	0.26	0.31	0.37	0.43	0.5	0.56	0.71	0.86	1.02	-	-	-
			Sones	12.1	12.7	14.3	15.6	17.2	18.7	22	27	32	-	-	-
	1825	1706	RPM	616	683	748	812	875	936	1053	1164	1268	1457	-	-
			BHP	0.31	0.37	0.43	0.49	0.56	0.63	0.78	0.94	1.1	1.45	-	-
			Sones	13.5	14.4	15.5	16.7	17.9	19.5	23	28	33	43	-	-
1950	1822	RPM	650	712	773	834	893	951	1064	1171	1273	1460	-	-	
		BHP	0.37	0.43	0.5	0.56	0.63	0.71	0.86	1.02	1.19	1.55	-	-	
		Sones	15.1	16.1	16.8	17.9	19.1	20	23	28	33	43	-	-	
2075	1939	RPM	684	742	800	857	913	969	1077	1181	1279	-	-	-	
		BHP	0.44	0.5	0.57	0.64	0.71	0.79	0.95	1.12	1.29	-	-	-	
		Sones	16.7	17.6	18.2	19.1	20	21	24	29	34	-	-	-	
2200	2056	RPM	718	773	828	882	935	988	1092	1192	1288	-	-	-	
		BHP	0.51	0.58	0.65	0.73	0.8	0.88	1.04	1.22	1.4	-	-	-	
		Sones	18.6	19.1	19.6	21	21	22	25	30	34	-	-	-	
2325	2173	RPM	752	805	857	908	959	1009	1108	1205	1298	-	-	-	
		BHP	0.6	0.67	0.74	0.82	0.9	0.98	1.15	1.33	1.52	-	-	-	
		Sones	20	21	21	22	23	24	27	30	35	-	-	-	
2450	2290	RPM	787	837	887	936	984	1032	1127	1219	-	-	-	-	
		BHP	0.69	0.77	0.84	0.92	1	1.09	1.26	1.45	-	-	-	-	
		Sones	22	22	23	23	24	25	28	32	-	-	-	-	
2575	2407	RPM	822	870	917	964	1010	1056	1147	1236	-	-	-	-	
		BHP	0.8	0.87	0.95	1.04	1.12	1.21	1.39	1.58	-	-	-	-	
		Sones	23	24	24	25	25	27	29	33	-	-	-	-	
2700	2523	RPM	858	903	949	993	1037	1081	1168	-	-	-	-	-	
		BHP	0.91	0.99	1.08	1.16	1.25	1.34	1.52	-	-	-	-	-	
		Sones	25	26	26	27	27	28	31	-	-	-	-	-	
2825	2640	RPM	893	937	980	1023	1065	1107	-	-	-	-	-	-	
		BHP	1.03	1.12	1.21	1.3	1.39	1.48	-	-	-	-	-	-	
		Sones	27	27	28	28	29	30	-	-	-	-	-	-	
2950	2757	RPM	929	971	1012	1053	1094	-	-	-	-	-	-	-	
		BHP	1.17	1.26	1.35	1.44	1.53	-	-	-	-	-	-	-	
		Sones	28	29	29	30	31	-	-	-	-	-	-	-	
3075	2874	RPM	965	1005	1045	1084	-	-	-	-	-	-	-	-	
		BHP	1.32	1.41	1.5	1.6	-	-	-	-	-	-	-	-	
		Sones	30	31	31	32	-	-	-	-	-	-	-	-	
3200	2991	RPM	1001	1040	-	-	-	-	-	-	-	-	-	-	
		BHP	1.48	1.57	-	-	-	-	-	-	-	-	-	-	
		Sones	32	33	-	-	-	-	-	-	-	-	-	-	



S&P Canada Ventilation Products, Inc., Div. of Soler & Palau Ventilation Group, certifies that the Model CSF shown herein are licensed to bear the AMCA Seal. The ratings shown are based on test and procedures performed in accordance with AMCA Publication 211 and AMCA Publication 311 and comply with the requirement of the AMCA Certified Ratings Program.



UL STANDARD 705

Performance certified is for installation type B: free inlet, ducted outlet. Power rating (BHP) does not include transmission losses. Performance ratings do not include the effects of appurtenances (accessories). The sound ratings shown are loudness values in fan sones at a distance of 1.5 m (5 ft) in a hemispherical free field calculated per AMCA International Standard 301. Values shown are for installation type B: ducted outlet hemispherical sone levels. Ratings do not include the effect of duct end correction.

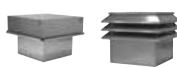

CSF12

MODEL CSF	CFM	OV		Static Pressure in Inches w.g.													
				1/8	1/4	3/8	1/2	5/8	3/4	1	1-1/4	1-1/2	2				
12	1150	767	RPM	338	-	-	-	-	-	-	-	-	-	-	-	-	
			BHP	0.08	-	-	-	-	-	-	-	-	-	-	-	-	-
			Sones	3.3	-	-	-	-	-	-	-	-	-	-	-	-	-
	1300	867	RPM	353	459	-	-	-	-	-	-	-	-	-	-	-	
			BHP	0.1	0.14	-	-	-	-	-	-	-	-	-	-	-	-
			Sones	4.1	5.4	-	-	-	-	-	-	-	-	-	-	-	-
	1450	967	RPM	372	464	-	-	-	-	-	-	-	-	-	-	-	
			BHP	0.12	0.17	-	-	-	-	-	-	-	-	-	-	-	-
			Sones	4.9	5.7	-	-	-	-	-	-	-	-	-	-	-	-
	1600	1067	RPM	394	475	563	-	-	-	-	-	-	-	-	-	-	
			BHP	0.15	0.2	0.27	-	-	-	-	-	-	-	-	-	-	-
			Sones	6.2	6.3	7.9	-	-	-	-	-	-	-	-	-	-	-
1750	1167	RPM	417	490	567	649	-	-	-	-	-	-	-	-	-		
		BHP	0.19	0.24	0.3	0.38	-	-	-	-	-	-	-	-	-	-	
		Sones	7.5	7.1	8.2	10.5	-	-	-	-	-	-	-	-	-	-	
1900	1267	RPM	441	507	577	651	-	-	-	-	-	-	-	-	-		
		BHP	0.23	0.28	0.35	0.43	-	-	-	-	-	-	-	-	-	-	
		Sones	8.5	8.1	8.7	10.7	-	-	-	-	-	-	-	-	-	-	
2050	1367	RPM	465	527	590	657	726	-	-	-	-	-	-	-	-		
		BHP	0.28	0.34	0.4	0.48	0.57	-	-	-	-	-	-	-	-	-	
		Sones	9.5	9.2	9.5	11.1	12.8	-	-	-	-	-	-	-	-	-	
2200	1467	RPM	491	548	606	667	730	795	-	-	-	-	-	-	-		
		BHP	0.33	0.4	0.46	0.54	0.63	0.73	-	-	-	-	-	-	-	-	
		Sones	10.6	10.5	10.5	11.8	13.1	14.9	-	-	-	-	-	-	-	-	
2350	1567	RPM	517	570	624	680	738	798	-	-	-	-	-	-	-		
		BHP	0.4	0.46	0.53	0.61	0.7	0.79	-	-	-	-	-	-	-	-	
		Sones	11.6	11.9	11.9	12.7	13.6	15.1	-	-	-	-	-	-	-	-	
2500	1667	RPM	544	593	643	695	748	804	918	-	-	-	-	-	-		
		BHP	0.47	0.54	0.61	0.69	0.78	0.87	1.1	-	-	-	-	-	-	-	
		Sones	12.9	13.7	13.2	13.6	14.3	15.5	19.1	-	-	-	-	-	-	-	
2650	1767	RPM	570	617	664	712	762	813	919	1029	-	-	-	-	-		
		BHP	0.55	0.62	0.7	0.78	0.87	0.96	1.18	1.44	-	-	-	-	-	-	
		Sones	14.2	14.9	14.9	14.8	15.2	16.1	19.1	24	-	-	-	-	-	-	
2800	1867	RPM	597	642	686	731	778	825	924	1026	-	-	-	-	-		
		BHP	0.64	0.72	0.8	0.88	0.97	1.06	1.28	1.53	-	-	-	-	-	-	
		Sones	15.6	16.4	16.3	16.1	16.3	16.9	19.5	24	-	-	-	-	-	-	
2950	1967	RPM	625	667	709	752	795	839	932	1028	-	-	-	-	-		
		BHP	0.74	0.82	0.9	0.99	1.08	1.18	1.39	1.64	-	-	-	-	-	-	
		Sones	17.1	17.9	18.1	17.5	17.4	17.8	20	24	-	-	-	-	-	-	
3100	2067	RPM	652	693	733	773	814	855	942	1032	1124	-	-	-	-		
		BHP	0.85	0.93	1.02	1.11	1.2	1.3	1.52	1.76	2.04	-	-	-	-	-	
		Sones	18.6	19.2	19.7	19.1	18.9	19.1	21	24	28	-	-	-	-	-	
3250	2167	RPM	680	718	757	795	834	873	954	1039	-	-	-	-	-		
		BHP	0.97	1.06	1.15	1.24	1.34	1.44	1.65	1.9	-	-	-	-	-	-	
		Sones	20	20	21	21	21	20	22	25	-	-	-	-	-	-	
3400	2267	RPM	708	745	781	818	855	892	969	1048	-	-	-	-	-		
		BHP	1.1	1.19	1.29	1.38	1.48	1.58	1.8	2.05	-	-	-	-	-	-	
		Sones	21	22	22	23	22	22	23	25	-	-	-	-	-	-	
3550	2367	RPM	736	771	806	841	876	912	984	-	-	-	-	-	-		
		BHP	1.24	1.34	1.44	1.54	1.64	1.74	1.97	-	-	-	-	-	-	-	
		Sones	23	24	24	25	24	24	25	-	-	-	-	-	-	-	
3700	2467	RPM	764	798	832	865	899	933	1002	-	-	-	-	-	-		
		BHP	1.4	1.5	1.6	1.71	1.81	1.92	2.14	-	-	-	-	-	-	-	
		Sones	25	25	25	26	26	25	26	-	-	-	-	-	-	-	
3850	2567	RPM	792	825	857	890	922	954	-	-	-	-	-	-	-		
		BHP	1.57	1.67	1.78	1.89	2	2.1	-	-	-	-	-	-	-	-	
		Sones	26	26	27	27	27	26	-	-	-	-	-	-	-	-	
4000	2667	RPM	820	852	883	914	-	-	-	-	-	-	-	-	-		
		BHP	1.75	1.86	1.97	2.08	-	-	-	-	-	-	-	-	-	-	
		Sones	27	28	28	29	-	-	-	-	-	-	-	-	-	-	
4150	2767	RPM	849	879	-	-	-	-	-	-	-	-	-	-	-		
		BHP	1.94	2.06	-	-	-	-	-	-	-	-	-	-	-	-	
		Sones	28	29	-	-	-	-	-	-	-	-	-	-	-	-	



S&P Canada Ventilation Products, Inc., Div. of Soler & Palau Ventilation Group, certifies that the Model CSF shown herein are licensed to bear the AMCA Seal. The ratings shown are based on test and procedures performed in accordance with AMCA Publication 211 and AMCA Publication 311 and comply with the requirement of the AMCA Certified Ratings Program.



UL STANDARD 705

Performance certified is for installation type B: free inlet, ducted outlet. Power rating (BHP) does not include transmission losses. Performance ratings do not include the effects of appurtenances (accessories). The sound ratings shown are loudness values in fan sones at a distance of 1.5 m (5 ft) in a hemispherical free field calculated per AMCA International Standard 301. Values shown are for installation type B: ducted outlet hemispherical sone levels. Ratings do not include the effect of duct end correction.

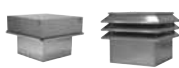

CSF 15

MODEL CSF	CFM	OV		Static Pressure in Inches w.g.											
				1/8	1/4	3/8	1/2	5/8	3/4	1	1-1/4	1-1/2	2		
15	1625	763	RPM	285	-	-	-	-	-	-	-	-	-	-	-
			BHP	0.1	-	-	-	-	-	-	-	-	-	-	-
			Sones	3.6	-	-	-	-	-	-	-	-	-	-	-
	1825	857	RPM	296	389	-	-	-	-	-	-	-	-	-	-
			BHP	0.12	0.2	-	-	-	-	-	-	-	-	-	-
			Sones	4.1	6.4	-	-	-	-	-	-	-	-	-	-
	2125	998	RPM	319	398	475	-	-	-	-	-	-	-	-	-
			BHP	0.17	0.25	0.34	-	-	-	-	-	-	-	-	-
			Sones	4.9	6.8	9.1	-	-	-	-	-	-	-	-	-
	2325	1092	RPM	337	403	479	548	-	-	-	-	-	-	-	-
			BHP	0.22	0.29	0.38	0.49	-	-	-	-	-	-	-	-
			Sones	5.9	7.1	9.2	11.6	-	-	-	-	-	-	-	-
	2625	1232	RPM	367	421	488	550	-	-	-	-	-	-	-	-
			BHP	0.29	0.36	0.46	0.57	-	-	-	-	-	-	-	-
			Sones	7.2	7.9	9.8	11.7	-	-	-	-	-	-	-	-
	2825	1326	RPM	388	436	493	559	614	-	-	-	-	-	-	-
			BHP	0.36	0.43	0.52	0.63	0.75	-	-	-	-	-	-	-
			Sones	8.2	8.6	10.1	12.3	14.2	-	-	-	-	-	-	-
	3125	1467	RPM	420	462	510	566	624	673	-	-	-	-	-	-
			BHP	0.47	0.54	0.63	0.74	0.87	1	-	-	-	-	-	-
			Sones	9.7	9.9	10.9	12.6	14.8	16.9	-	-	-	-	-	-
3325	1561	RPM	442	481	524	572	629	680	775	-	-	-	-	-	
		BHP	0.55	0.63	0.72	0.83	0.95	1.09	1.39	-	-	-	-	-	
		Sones	10.8	11.1	11.7	13.1	15.2	17.5	21	-	-	-	-	-	-
3625	1702	RPM	476	510	548	590	637	688	777	-	-	-	-	-	
		BHP	0.7	0.78	0.87	0.98	1.11	1.24	1.55	-	-	-	-	-	
		Sones	12.6	12.6	13.1	14.2	15.7	18.1	22	-	-	-	-	-	-
3825	1796	RPM	499	531	566	604	646	693	782	867	-	-	-	-	
		BHP	0.82	0.9	0.99	1.1	1.22	1.36	1.67	2.02	-	-	-	-	
		Sones	13.8	13.9	14.3	15.1	16.3	18.4	22	26	-	-	-	-	-
4125	1937	RPM	534	562	594	628	665	704	793	869	-	-	-	-	
		BHP	1.01	1.1	1.19	1.3	1.42	1.56	1.87	2.22	-	-	-	-	
		Sones	15.6	15.7	16.1	16.7	17.8	19.2	23	26	-	-	-	-	-
4325	2031	RPM	557	584	613	645	679	715	798	877	951	-	-	-	
		BHP	1.16	1.25	1.34	1.45	1.58	1.71	2.02	2.37	2.76	-	-	-	
		Sones	16.9	17.1	17.3	17.8	18.9	19.8	23	26	29	-	-	-	-
4625	2171	RPM	593	617	644	672	703	735	807	887	957	-	-	-	
		BHP	1.4	1.49	1.6	1.71	1.83	1.97	2.27	2.62	3.01	-	-	-	
		Sones	19.1	19.3	19.4	19.9	21	22	24	27	30	-	-	-	-
4825	2265	RPM	616	640	664	691	720	750	816	892	964	-	-	-	
		BHP	1.59	1.68	1.78	1.9	2.02	2.16	2.46	2.81	3.2	-	-	-	
		Sones	21	21	21	22	22	23	25	27	31	-	-	-	-
5125	2406	RPM	652	673	697	721	747	775	834	898	-	-	-	-	
		BHP	1.89	1.99	2.09	2.21	2.33	2.47	2.78	3.12	-	-	-	-	
		Sones	23	24	24	24	24	25	26	28	-	-	-	-	-
5325	2500	RPM	676	696	718	742	766	792	848	-	-	-	-	-	
		BHP	2.11	2.21	2.32	2.44	2.57	2.7	3.01	-	-	-	-	-	
		Sones	25	25	25	25	25	26	27	-	-	-	-	-	-
5625	2641	RPM	712	731	751	773	796	820	-	-	-	-	-	-	
		BHP	2.48	2.58	2.69	2.81	2.94	3.08	-	-	-	-	-	-	
		Sones	27	27	27	27	27	28	-	-	-	-	-	-	-
5825	2735	RPM	736	754	774	794	-	-	-	-	-	-	-	-	
		BHP	2.74	2.85	2.97	3.09	-	-	-	-	-	-	-	-	
		Sones	28	29	28	29	-	-	-	-	-	-	-	-	-
6125	2876	RPM	772	789	-	-	-	-	-	-	-	-	-	-	
		BHP	3.17	3.29	-	-	-	-	-	-	-	-	-	-	
		Sones	31	32	-	-	-	-	-	-	-	-	-	-	-



S&P Canada Ventilation Products, Inc., Div. of Soler & Palau Ventilation Group, certifies that the Model CSF shown herein are licensed to bear the AMCA Seal. The ratings shown are based on test and procedures performed in accordance with AMCA Publication 211 and AMCA Publication 311 and comply with the requirement of the AMCA Certified Ratings Program.



UL STANDARD 705

Performance certified is for installation type B: free inlet, ducted outlet. Power rating (BHP) does not include transmission losses. Performance ratings do not include the effects of appurtenances (accessories). The sound ratings shown are loudness values in fan sones at a distance of 1.5 m (5 ft) in a hemispherical free field calculated per AMCA International Standard 301. Values shown are for installation type B: ducted outlet hemispherical sone levels. Ratings do not include the effect of duct end correction.

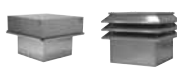

CSF18

MODEL CSF	CFM	OV		Static Pressure in Inches w.g.									
				1/8	1/4	3/8	1/2	5/8	3/4	1	1-1/4	1-1/2	2
2250	765	RPM	253	-	-	-	-	-	-	-	-	-	-
		BHP	0.14	-	-	-	-	-	-	-	-	-	-
		Sones	2.1	-	-	-	-	-	-	-	-	-	-
2600	884	RPM	269	336	-	-	-	-	-	-	-	-	-
		BHP	0.18	0.26	-	-	-	-	-	-	-	-	-
		Sones	2.8	3.4	-	-	-	-	-	-	-	-	-
2950	1003	RPM	283	346	404	459	509	-	-	-	-	-	-
		BHP	0.23	0.32	0.42	0.54	0.66	-	-	-	-	-	-
		Sones	3.5	3.9	4.7	5.9	7.1	-	-	-	-	-	-
3300	1122	RPM	302	359	413	465	513	558	-	-	-	-	-
		BHP	0.3	0.4	0.5	0.62	0.75	0.89	-	-	-	-	-
		Sones	4.4	4.5	5.2	6.3	7.3	8.7	-	-	-	-	-
3650	1241	RPM	323	375	426	473	519	563	643	716	-	-	-
		BHP	0.38	0.49	0.6	0.72	0.86	1	1.31	1.65	-	-	-
		Sones	5.5	5.4	6.1	6.7	7.7	9.1	12.4	14.5	-	-	-
4000	1361	RPM	344	392	438	483	527	568	647	719	-	-	-
		BHP	0.48	0.59	0.71	0.84	0.98	1.13	1.45	1.79	-	-	-
		Sones	6.8	6.3	6.7	7.3	8.2	9.4	12.6	14.7	-	-	-
4350	1480	RPM	365	410	453	497	536	576	652	722	787	-	-
		BHP	0.6	0.72	0.84	0.98	1.12	1.27	1.6	1.96	2.34	-	-
		Sones	7.9	7.4	7.6	8.2	8.9	10.1	13.1	14.9	16.7	-	-
4700	1599	RPM	387	429	470	509	550	586	658	726	790	-	-
		BHP	0.73	0.86	1	1.14	1.28	1.44	1.78	2.15	2.54	-	-
		Sones	9.7	8.6	8.7	9.1	9.9	11.1	13.4	15.3	17.2	-	-
5050	1718	RPM	410	450	488	525	563	597	666	732	794	909	-
		BHP	0.88	1.02	1.17	1.31	1.47	1.63	1.98	2.35	2.76	3.63	-
		Sones	12.1	10.2	10.1	10.4	11.2	11.9	14.1	15.8	17.6	21	-
5400	1837	RPM	433	470	506	541	576	611	675	739	799	912	-
		BHP	1.06	1.21	1.36	1.52	1.68	1.84	2.2	2.58	3	3.89	-
		Sones	14.6	12.1	11.7	11.8	12.3	13.3	14.7	16.3	17.9	22	-
5750	1956	RPM	456	492	526	559	591	624	686	747	806	916	-
		BHP	1.25	1.42	1.58	1.74	1.91	2.08	2.45	2.84	3.26	4.17	-
		Sones	17.7	13.9	13.5	13.4	13.7	14.5	15.6	16.9	18.5	22	-
6100	2075	RPM	479	513	546	577	608	639	701	757	813	921	-
		BHP	1.47	1.65	1.82	1.99	2.17	2.35	2.72	3.13	3.56	4.48	-
		Sones	21	16.1	15.5	15.1	15.3	15.8	16.7	17.7	19.1	22	-
6450	2194	RPM	503	535	566	596	626	655	714	768	822	927	-
		BHP	1.72	1.91	2.09	2.27	2.45	2.64	3.03	3.44	3.88	4.83	-
		Sones	24	18.7	17.3	16.8	16.9	17.1	17.8	18.6	19.7	23	-
6800	2313	RPM	527	558	587	616	644	672	727	782	833	934	-
		BHP	1.99	2.19	2.38	2.57	2.76	2.96	3.36	3.79	4.23	5.2	-
		Sones	26	21	19.1	18.6	18.8	18.4	18.9	19.7	21	23	-
7150	2432	RPM	551	580	609	636	663	690	742	794	844	942	-
		BHP	2.3	2.5	2.7	2.9	3.11	3.31	3.73	4.16	4.62	5.6	-
		Sones	28	24	21	21	20	19.9	20	21	22	24	-
7500	2551	RPM	575	603	630	657	683	709	759	808	859	951	-
		BHP	2.63	2.85	3.06	3.27	3.48	3.69	4.12	4.57	5.04	6.04	-
		Sones	30	27	23	22	22	22	22	22	23	25	-
7850	2670	RPM	599	626	652	678	703	728	776	824	871	961	-
		BHP	2.99	3.22	3.44	3.66	3.88	4.1	4.55	5.01	5.5	6.52	-
		Sones	32	29	25	24	24	24	24	24	25	26	-
8200	2789	RPM	623	649	675	699	723	747	794	840	885	973	-
		BHP	3.38	3.63	3.86	4.09	4.32	4.55	5.02	5.49	5.99	7.03	-
		Sones	34	32	27	26	25	25	25	25	26	27	-

18



S&P Canada Ventilation Products, Inc., Div. of Soler & Palau Ventilation Group, certifies that the Model CSF shown herein are licensed to bear the AMCA Seal. The ratings shown are based on test and procedures performed in accordance with AMCA Publication 211 and AMCA Publication 311 and comply with the requirement of the AMCA Certified Ratings Program.



UL STANDARD 705

Performance certified is for installation type B: free inlet, ducted outlet. Power rating (BHP) does not include transmission losses. Performance ratings do not include the effects of appurtenances (accessories). The sound ratings shown are loudness values in fan sones at a distance of 1.5 m (5 ft) in a hemispherical free field calculated per AMCA International Standard 301. Values shown are for installation type B: ducted outlet hemispherical sone levels. Ratings do not include the effect of duct end correction.

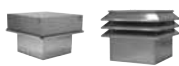

CSF18 Cont.

MODEL CSF	CFM	OV		Static Pressure in Inches w.g.									
				1/8	1/4	3/8	1/2	5/8	3/4	1	1-1/4	1-1/2	2
18	8550	2908	RPM	647	673	697	721	744	767	812	856	900	987
			BHP	3.81	4.07	4.31	4.55	4.79	5.03	5.51	6.01	6.51	7.58
			Sones	36	35	30	28	27	27	27	27	28	29
	8900	3027	RPM	672	696	720	743	766	788	831	874	916	-
			BHP	4.28	4.54	4.8	5.05	5.3	5.55	6.05	6.56	7.08	-
			Sones	39	39	34	30	29	29	29	29	29	-
	9250	3146	RPM	696	720	743	765	787	808	851	892	933	-
			BHP	4.78	5.06	5.33	5.59	5.85	6.11	6.63	7.15	7.69	-
			Sones	41	42	37	33	31	31	31	31	31	-
	9600	3265	RPM	721	744	766	788	809	829	870	910	-	-
			BHP	5.32	5.61	5.89	6.16	6.43	6.7	7.24	7.78	-	-
			Sones	44	45	41	37	34	34	34	34	-	-
	9950	3384	RPM	745	768	789	810	831	851	-	-	-	-
			BHP	5.9	6.2	6.49	6.78	7.06	7.34	-	-	-	-
			Sones	48	49	45	41	37	36	-	-	-	-
	10300	3503	RPM	771	796	819	840	862	-	-	-	-	-
			BHP	6.5	6.9	7.2	7.5	7.8	-	-	-	-	-
			Sones	52	53	51	46	42	-	-	-	-	-
	10650	3622	RPM	796	820	842	-	-	-	-	-	-	-
			BHP	7.3	7.6	7.8	-	-	-	-	-	-	-
			Sones	56	57	56	-	-	-	-	-	-	-



S&P Canada Ventilation Products, Inc., Div. of Soler & Palau Ventilation Group, certifies that the Model CSF shown herein are licensed to bear the AMCA Seal. The ratings shown are based on test and procedures performed in accordance with AMCA Publication 211 and AMCA Publication 311 and comply with the requirement of the AMCA Certified Ratings Program.



UL STANDARD 705

Performance certified is for installation type B: free inlet, ducted outlet. Power rating (BHP) does not include transmission losses. Performance ratings do not include the effects of appurtenances (accessories). The sound ratings shown are loudness values in fan sones at a distance of 1.5 m (5 ft) in a hemispherical free field calculated per AMCA International Standard 301. Values shown are for installation type B: ducted outlet hemispherical sone levels. Ratings do not include the effect of duct end correction.

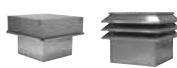

CSF20

MODEL CSF	CFM	OV		Static Pressure in Inches w.g.										
				1/8	1/4	3/8	1/2	5/8	3/4	1	1-1/4	1-1/2	2	
20	2800	698	RPM	223	288	342	-	-	-	-	-	-	-	-
			BHP	0.16	0.25	0.35	-	-	-	-	-	-	-	-
			Sones	3.7	5.4	7.6	-	-	-	-	-	-	-	-
	3340	833	RPM	241	299	351	397	-	-	-	-	-	-	-
			BHP	0.22	0.32	0.44	0.56	-	-	-	-	-	-	-
			Sones	4.8	6.2	8.5	10.8	-	-	-	-	-	-	-
	3880	968	RPM	262	313	361	405	-	-	-	-	-	-	-
			BHP	0.31	0.42	0.55	0.68	-	-	-	-	-	-	-
			Sones	6.1	7.2	9.3	11.7	-	-	-	-	-	-	-
	4420	1102	RPM	285	331	375	416	455	-	-	-	-	-	-
			BHP	0.42	0.55	0.68	0.83	0.98	-	-	-	-	-	-
			Sones	7.6	8.6	10.6	12.9	14.8	-	-	-	-	-	-
	4960	1237	RPM	310	350	390	429	465	500	-	-	-	-	-
			BHP	0.57	0.7	0.84	1	1.16	1.33	-	-	-	-	-
			Sones	9.3	10.3	12.1	14.3	15.8	17.3	-	-	-	-	-
	5500	1372	RPM	335	372	408	444	478	511	-	-	-	-	-
			BHP	0.74	0.88	1.03	1.2	1.37	1.55	-	-	-	-	-
			Sones	11.3	12.4	13.9	15.7	16.9	18.4	-	-	-	-	-
	6040	1506	RPM	361	394	428	461	493	524	-	-	-	-	-
			BHP	0.96	1.1	1.26	1.44	1.62	1.81	-	-	-	-	-
			Sones	13.9	14.8	16.3	17.3	18.4	19.6	-	-	-	-	-
	6580	1641	RPM	388	418	449	479	510	539	596	649	-	-	-
			BHP	1.21	1.36	1.53	1.71	1.91	2.11	2.53	2.98	-	-	-
			Sones	16.8	17.5	18.4	19.1	20	21	24	27	-	-	-
7120	1776	RPM	415	443	471	499	527	557	609	661	709	800	-	
		BHP	1.51	1.67	1.85	2.04	2.24	2.45	2.89	3.36	3.85	4.85	-	
		Sones	19.8	20	20	21	22	23	25	28	32	40	-	
7660	1910	RPM	442	468	494	521	547	573	624	673	721	809	-	
		BHP	1.85	2.02	2.21	2.4	2.61	2.83	3.3	3.79	4.29	5.36	-	
		Sones	22	22	22	23	24	25	27	30	34	42	-	
8200	2045	RPM	470	494	518	543	568	592	641	687	733	819	-	
		BHP	2.25	2.43	2.62	2.82	3.04	3.27	3.75	4.26	4.79	5.9	-	
		Sones	25	25	25	26	26	27	29	32	35	43	-	
8740	2180	RPM	497	520	543	566	589	612	658	703	746	830	-	
		BHP	2.7	2.88	3.09	3.3	3.52	3.76	4.26	4.78	5.33	6.49	-	
		Sones	27	28	28	28	28	29	31	34	37	45	-	
9280	2314	RPM	525	547	568	590	612	634	677	719	761	842	-	
		BHP	3.2	3.4	3.61	3.83	4.06	4.31	4.82	5.36	5.93	7.13	-	
		Sones	30	31	30	31	31	32	34	36	40	47	-	
9820	2449	RPM	554	574	594	615	635	656	697	737	777	855	-	
		BHP	3.77	3.98	4.2	4.43	4.67	4.92	5.45	6.01	6.6	7.84	-	
		Sones	33	34	33	33	34	34	37	39	42	50	-	
10360	2584	RPM	582	601	620	640	659	678	717	756	795	-	-	
		BHP	4.41	4.62	4.85	5.09	5.33	5.59	6.14	6.71	7.32	-	-	
		Sones	35	37	37	36	37	37	40	42	45	-	-	
10900	2718	RPM	610	628	647	665	683	702	739	776	-	-	-	
		BHP	5.11	5.33	5.57	5.81	6.07	6.34	6.9	7.49	-	-	-	
		Sones	38	39	39	39	40	41	43	46	-	-	-	
11440	2853	RPM	639	656	673	691	708	726	761	-	-	-	-	
		BHP	5.88	6.12	6.36	6.62	6.88	7.16	7.73	-	-	-	-	
		Sones	41	43	43	44	44	45	47	-	-	-	-	
11980	2988	RPM	667	684	700	717	734	-	-	-	-	-	-	
		BHP	6.73	6.97	7.23	7.49	7.77	-	-	-	-	-	-	
		Sones	45	47	48	48	49	-	-	-	-	-	-	
12520	3122	RPM	696	-	-	-	-	-	-	-	-	-	-	
		BHP	7.66	-	-	-	-	-	-	-	-	-	-	
		Sones	50	-	-	-	-	-	-	-	-	-	-	



S&P Canada Ventilation Products, Inc., Div. of Soler & Palau Ventilation Group, certifies that the Model CSF shown herein are licensed to bear the AMCA Seal. The ratings shown are based on test and procedures performed in accordance with AMCA Publication 211 and AMCA Publication 311 and comply with the requirement of the AMCA Certified Ratings Program.



Performance certified is for installation type B: free inlet, ducted outlet. Power rating (BHP) does not include transmission losses. Performance ratings do not include the effects of appurtenances (accessories). The sound ratings shown are loudness values in fan sones at a distance of 1.5 m (5 ft) in a hemispherical free field calculated per AMCA International Standard 301. Values shown are for installation type B: ducted outlet hemispherical sone levels. Ratings do not include the effect of duct end correction.

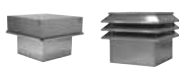

LSF PERFORMANCE

LSF 9

MODEL LSF	CFM	OV		Static Pressure in Inches w.g.							
				1/8	1/4	3/8	1/2	5/8	3/4	1	
9	475	540	RPM	431	-	-	-	-	-	-	-
			BHP	0.03	-	-	-	-	-	-	-
			Sones	4.1	-	-	-	-	-	-	-
	575	653	RPM	437	-	-	-	-	-	-	-
			BHP	0.04	-	-	-	-	-	-	-
			Sones	4.3	-	-	-	-	-	-	-
	675	767	RPM	455	-	-	-	-	-	-	-
			BHP	0.05	-	-	-	-	-	-	-
			Sones	4.9	-	-	-	-	-	-	-
	775	881	RPM	480	614	-	-	-	-	-	-
			BHP	0.06	0.1	-	-	-	-	-	-
			Sones	5.8	10.3	-	-	-	-	-	-
	875	994	RPM	509	628	-	-	-	-	-	-
			BHP	0.08	0.12	-	-	-	-	-	-
			Sones	6.9	11	-	-	-	-	-	-
	975	1108	RPM	540	647	755	-	-	-	-	-
			BHP	0.1	0.14	0.19	-	-	-	-	-
			Sones	8.3	11.9	15.2	-	-	-	-	-
	1075	1222	RPM	574	672	769	867	-	-	-	-
			BHP	0.13	0.17	0.22	0.27	-	-	-	-
			Sones	9.8	13	15.7	18.9	-	-	-	-
	1175	1335	RPM	610	700	789	878	-	-	-	-
			BHP	0.16	0.2	0.25	0.31	-	-	-	-
			Sones	11.7	14	16.4	19.3	-	-	-	-
	1275	1449	RPM	646	731	814	894	976	-	-	-
			BHP	0.2	0.24	0.29	0.35	0.41	-	-	-
			Sones	13.7	15.3	17.4	20	25	-	-	-
1375	1563	RPM	683	763	840	915	991	1067	-	-	
		BHP	0.24	0.29	0.34	0.4	0.46	0.53	-	-	
		Sones	15.3	16.7	18.5	22	26	32	-	-	
1475	1676	RPM	721	796	868	939	1009	1080	1223		
		BHP	0.29	0.34	0.39	0.45	0.52	0.59	0.75		
		Sones	16.8	18.1	19.7	23	28	33	48		
1575	1790	RPM	759	832	899	965	1031	1098	1231		
		BHP	0.34	0.4	0.46	0.52	0.58	0.65	0.81		
		Sones	18.4	19.8	21	25	29	35	49		
1675	1903	RPM	797	867	931	994	1056	1118	1243		
		BHP	0.41	0.47	0.52	0.59	0.65	0.72	0.88		
		Sones	20	22	24	27	32	36	50		
1775	2017	RPM	837	903	965	1024	1084	1142	1259		
		BHP	0.48	0.54	0.6	0.66	0.73	0.81	0.96		
		Sones	22	24	26	30	34	39	52		
1875	2131	RPM	876	940	999	1056	1112	1168	1279		
		BHP	0.55	0.62	0.68	0.75	0.82	0.9	1.06		
		Sones	24	26	29	33	37	42	55		
1975	2244	RPM	915	978	1034	1089	1142	1195	-		
		BHP	0.64	0.71	0.78	0.85	0.92	0.99	-		
		Sones	26	29	32	36	40	45	-		
2075	2358	RPM	955	1015	1070	1123	1174	1224	-		
		BHP	0.73	0.81	0.88	0.95	1.03	1.1	-		
		Sones	29	32	36	40	44	49	-		
2175	2472	RPM	995	1053	1107	1157	-	-	-		
		BHP	0.84	0.91	0.99	1.07	-	-	-		
		Sones	33	36	39	44	-	-	-		
2275	2585	RPM	1035	1092	-	-	-	-	-		
		BHP	0.95	1.03	-	-	-	-	-		
		Sones	36	40	-	-	-	-	-		
2375	2699	RPM	1075	-	-	-	-	-	-		
		BHP	1.07	-	-	-	-	-	-		
		Sones	40	-	-	-	-	-	-		



S&P Canada Ventilation Products, Inc., Div. of Soler & Palau Ventilation Group, certifies that the Model LSF shown herein are licensed to bear the AMCA Seal. The ratings shown are based on test and procedures performed in accordance with AMCA Publication 211 and AMCA Publication 311 and comply with the requirement of the AMCA Certified Ratings Program.



UL STANDARD 705

Performance certified is for installation type B: free inlet, ducted outlet. Power rating (BHP) does not include transmission losses. Performance ratings do not include the effects of appurtenances (accessories). The sound ratings shown are loudness values in fan sones at a distance of 1.5 m (5 ft) in a hemispherical free field calculated per AMCA International Standard 301. Values shown are for installation type B: ducted outlet hemispherical sone levels. Ratings do not include the effect of duct end correction.

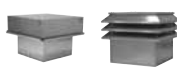

LSF 10

MODEL LSF	CFM	OV		Static Pressure in Inches w.g.										
				1/8	1/4	3/8	1/2	5/8	3/4	1	1-1/4	1-1/2		
10	950	888	RPM	421	-	-	-	-	-	-	-	-	-	-
			BHP	0.07	-	-	-	-	-	-	-	-	-	-
			Sones	5.5	-	-	-	-	-	-	-	-	-	-
	1075	1005	RPM	444	-	-	-	-	-	-	-	-	-	-
			BHP	0.09	-	-	-	-	-	-	-	-	-	-
			Sones	6.3	-	-	-	-	-	-	-	-	-	-
	1200	1121	RPM	470	572	-	-	-	-	-	-	-	-	-
			BHP	0.11	0.16	-	-	-	-	-	-	-	-	-
			Sones	7.2	10.3	-	-	-	-	-	-	-	-	-
	1325	1238	RPM	498	592	682	-	-	-	-	-	-	-	-
BHP			0.14	0.19	0.25	-	-	-	-	-	-	-	-	
Sones			8.3	11.4	14.5	-	-	-	-	-	-	-	-	
1450	1355	RPM	528	615	698	-	-	-	-	-	-	-	-	
		BHP	0.18	0.23	0.29	-	-	-	-	-	-	-	-	
		Sones	9.6	12.6	15.1	-	-	-	-	-	-	-	-	
1575	1472	RPM	559	639	717	793	866	-	-	-	-	-	-	
		BHP	0.22	0.28	0.34	0.4	0.47	-	-	-	-	-	-	
		Sones	11	13.9	16.2	18.3	22	-	-	-	-	-	-	
1700	1589	RPM	591	666	739	810	879	947	1074	-	-	-	-	
		BHP	0.27	0.33	0.39	0.46	0.53	0.61	0.78	-	-	-	-	
		Sones	12.5	15.1	17.1	19.2	23	24	31	-	-	-	-	
1825	1706	RPM	623	694	762	829	895	959	1082	1196	-	-	-	
		BHP	0.32	0.39	0.45	0.52	0.6	0.68	0.85	1.04	-	-	-	
		Sones	14.3	16.4	18.3	20	23	25	31	38	-	-	-	
1950	1822	RPM	657	723	787	851	913	974	1092	1203	1308	-	-	
		BHP	0.39	0.45	0.52	0.59	0.67	0.75	0.93	1.13	1.33	-	-	
		Sones	15.7	17.9	19.5	21	24	26	32	38	45	-	-	
2075	1939	RPM	691	753	814	874	933	991	1104	1212	1315	-	-	
		BHP	0.46	0.52	0.6	0.67	0.75	0.83	1.02	1.22	1.43	-	-	
		Sones	17	19.5	21	22	25	27	33	39	46	-	-	
2200	2056	RPM	725	784	841	898	954	1010	1118	1223	1323	-	-	
		BHP	0.54	0.61	0.68	0.76	0.84	0.93	1.11	1.32	1.53	-	-	
		Sones	18.5	21	22	24	26	28	34	40	46	-	-	
2325	2173	RPM	759	815	870	924	978	1030	1134	1235	-	-	-	
		BHP	0.63	0.7	0.78	0.86	0.94	1.03	1.22	1.43	-	-	-	
		Sones	20	22	24	25	28	29	35	41	-	-	-	
2450	2290	RPM	794	847	900	951	1002	1053	1152	1249	-	-	-	
		BHP	0.72	0.8	0.88	0.96	1.05	1.14	1.34	1.55	-	-	-	
		Sones	22	24	25	27	30	31	36	42	-	-	-	
2575	2407	RPM	829	880	930	979	1028	1076	1172	-	-	-	-	
		BHP	0.83	0.91	1	1.08	1.17	1.27	1.46	-	-	-	-	
		Sones	25	26	27	28	31	33	38	-	-	-	-	
2700	2523	RPM	865	913	961	1008	1055	1101	-	-	-	-	-	
		BHP	0.95	1.03	1.12	1.21	1.3	1.4	-	-	-	-	-	
		Sones	26	27	29	30	33	34	-	-	-	-	-	
2825	2640	RPM	900	947	993	1038	1083	1127	-	-	-	-	-	
		BHP	1.08	1.17	1.26	1.35	1.45	1.55	-	-	-	-	-	
		Sones	28	29	31	32	35	36	-	-	-	-	-	
2950	2757	RPM	936	981	1025	1068	-	-	-	-	-	-	-	
		BHP	1.22	1.31	1.41	1.5	-	-	-	-	-	-	-	
		Sones	30	31	33	34	-	-	-	-	-	-	-	
3075	2874	RPM	972	1015	1057	-	-	-	-	-	-	-	-	
		BHP	1.37	1.47	1.57	-	-	-	-	-	-	-	-	
		Sones	32	33	35	-	-	-	-	-	-	-	-	
3200	2991	RPM	1008	-	-	-	-	-	-	-	-	-	-	
		BHP	1.54	-	-	-	-	-	-	-	-	-	-	
		Sones	34	-	-	-	-	-	-	-	-	-	-	



S&P Canada Ventilation Products, Inc., Div. of Soler & Palau Ventilation Group, certifies that the Model LSF shown herein are licensed to bear the AMCA Seal. The ratings shown are based on test and procedures performed in accordance with AMCA Publication 211 and AMCA Publication 311 and comply with the requirement of the AMCA Certified Ratings Program.



UL STANDARD 705

Performance certified is for installation type B: free inlet, ducted outlet. Power rating (BHP) does not include transmission losses. Performance ratings do not include the effects of appurtenances (accessories). The sound ratings shown are loudness values in fan sones at a distance of 1.5 m (5 ft) in a hemispherical free field calculated per AMCA International Standard 301. Values shown are for installation type B: ducted outlet hemispherical sone levels. Ratings do not include the effect of duct end correction.

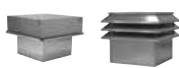

LSF 12

MODEL LSF	CFM	OV		Static Pressure in Inches w.g.								
				1/8	1/4	3/8	1/2	5/8	3/4	1	1-1/4	
12	1450	967	RPM	391	478	575	-	-	-	-	-	-
			BHP	0.14	0.2	0.28	-	-	-	-	-	-
			Sones	6.4	8	11.1	-	-	-	-	-	-
	1600	1067	RPM	414	492	576	-	-	-	-	-	-
			BHP	0.18	0.24	0.31	-	-	-	-	-	-
			Sones	7.5	8.6	11.2	-	-	-	-	-	-
	1750	1167	RPM	439	510	583	663	-	-	-	-	-
			BHP	0.22	0.28	0.36	0.46	-	-	-	-	-
			Sones	8.6	9.4	11.6	14.1	-	-	-	-	-
	1900	1267	RPM	465	530	596	667	742	-	-	-	-
			BHP	0.27	0.33	0.41	0.5	0.62	-	-	-	-
			Sones	9.8	10.5	12.4	14.5	16.8	-	-	-	-
	2050	1367	RPM	491	552	613	676	743	-	-	-	-
			BHP	0.33	0.4	0.47	0.56	0.67	-	-	-	-
			Sones	11.2	11.7	13.1	14.9	16.9	-	-	-	-
	2200	1467	RPM	518	576	632	689	749	813	-	-	-
			BHP	0.4	0.47	0.54	0.63	0.74	0.86	-	-	-
			Sones	12.7	13.1	13.9	15.3	17.2	20	-	-	-
	2350	1567	RPM	545	600	652	705	760	818	-	-	-
			BHP	0.47	0.55	0.63	0.72	0.82	0.94	-	-	-
			Sones	13.9	14.5	15.1	16.2	17.7	20	-	-	-
	2500	1667	RPM	573	625	675	724	775	827	938	-	-
			BHP	0.56	0.64	0.72	0.81	0.91	1.03	1.3	-	-
			Sones	15.4	15.7	16.2	17.3	18.6	21	26	-	-
	2650	1767	RPM	601	651	698	744	791	840	941	-	-
			BHP	0.65	0.74	0.82	0.92	1.02	1.13	1.39	-	-
			Sones	16.8	17.3	17.7	18.6	20	22	26	-	-
	2800	1867	RPM	629	677	722	766	810	855	949	1049	-
			BHP	0.76	0.85	0.94	1.04	1.14	1.25	1.51	1.82	-
			Sones	18.1	18.9	19.2	20	21	22	27	31	-
2950	1967	RPM	657	703	747	789	830	873	960	1052	-	
		BHP	0.87	0.97	1.07	1.17	1.27	1.38	1.63	1.94	-	
		Sones	19.4	20	20	21	22	23	27	32	-	
3100	2067	RPM	685	730	772	812	852	892	973	1059	-	
		BHP	1	1.11	1.21	1.31	1.42	1.53	1.78	2.07	-	
		Sones	21	22	22	23	23	25	28	32	-	
3250	2167	RPM	714	758	798	836	874	912	989	-	-	
		BHP	1.14	1.25	1.36	1.47	1.58	1.69	1.94	-	-	
		Sones	22	23	24	24	25	26	29	-	-	
3400	2267	RPM	742	785	824	861	898	934	-	-	-	
		BHP	1.3	1.42	1.53	1.64	1.75	1.87	-	-	-	
		Sones	24	25	25	26	26	27	-	-	-	
3550	2367	RPM	771	813	850	886	921	956	-	-	-	
		BHP	1.47	1.59	1.71	1.82	1.94	2.06	-	-	-	
		Sones	25	26	27	27	28	29	-	-	-	
3700	2467	RPM	800	840	877	912	-	-	-	-	-	
		BHP	1.65	1.78	1.9	2.02	-	-	-	-	-	
		Sones	27	28	28	28	-	-	-	-	-	
3850	2567	RPM	829	868	904	-	-	-	-	-	-	
		BHP	1.85	1.98	2.11	-	-	-	-	-	-	
		Sones	28	29	30	-	-	-	-	-	-	
4000	2667	RPM	858	-	-	-	-	-	-	-	-	
		BHP	2.06	-	-	-	-	-	-	-	-	
		Sones	30	-	-	-	-	-	-	-	-	

S&P Canada Ventilation Products, Inc., Div. of Soler & Palau Ventilation Group, certifies that the Model LSF shown herein are licensed to bear the AMCA Seal. The ratings shown are based on test and procedures performed in accordance with AMCA Publication 211 and AMCA Publication 311 and comply with the requirement of the AMCA Certified Ratings Program.



UL STANDARD 705

Performance certified is for installation type B: free inlet, ducted outlet. Power rating (BHP) does not include transmission losses. Performance ratings do not include the effects of appurtenances (accessories). The sound ratings shown are loudness values in fan sones at a distance of 1.5 m (5 ft) in a hemispherical free field calculated per AMCA International Standard 301. Values shown are for installation type B: ducted outlet hemispherical sone levels. Ratings do not include the effect of duct end correction.

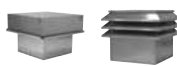

LSF 15

MODEL LSF	CFM	OV		Static Pressure in Inches w.g.										
				1/8	1/4	3/8	1/2	5/8	3/4	1	1-1/4	1-1/2		
15	1625	763	RPM	293	-	-	-	-	-	-	-	-	-	-
			BHP	0.1	-	-	-	-	-	-	-	-	-	-
			Sones	4.5	-	-	-	-	-	-	-	-	-	-
	1825	857	RPM	305	390	-	-	-	-	-	-	-	-	-
			BHP	0.13	0.19	-	-	-	-	-	-	-	-	-
			Sones	5.1	6.8	-	-	-	-	-	-	-	-	-
	2125	998	RPM	330	403	475	-	-	-	-	-	-	-	-
			BHP	0.18	0.25	0.33	-	-	-	-	-	-	-	-
			Sones	6.3	7.6	9.6	-	-	-	-	-	-	-	-
	2325	1092	RPM	348	416	480	547	-	-	-	-	-	-	-
			BHP	0.22	0.29	0.37	0.47	-	-	-	-	-	-	-
			Sones	7.2	8.2	9.8	11.7	-	-	-	-	-	-	-
	2625	1232	RPM	377	434	495	552	612	-	-	-	-	-	-
			BHP	0.3	0.37	0.46	0.55	0.67	-	-	-	-	-	-
			Sones	8.7	9.3	10.5	12.1	14.1	-	-	-	-	-	-
2825	1326	RPM	397	451	508	559	615	670	-	-	-	-	-	
		BHP	0.36	0.43	0.53	0.62	0.73	0.86	-	-	-	-	-	
		Sones	9.6	10.2	11.3	12.4	14.3	16.4	-	-	-	-	-	
3125	1467	RPM	428	477	525	578	624	674	-	-	-	-	-	
		BHP	0.47	0.55	0.64	0.74	0.85	0.97	-	-	-	-	-	
		Sones	11.4	11.6	12.4	13.8	14.9	16.8	-	-	-	-	-	
3325	1561	RPM	449	495	541	590	634	680	-	-	-	-	-	
		BHP	0.55	0.64	0.73	0.84	0.94	1.07	-	-	-	-	-	
		Sones	12.7	12.8	13.4	14.6	15.7	17.1	-	-	-	-	-	
3625	1702	RPM	482	524	566	608	655	694	779	-	-	-	-	
		BHP	0.7	0.79	0.89	0.99	1.11	1.23	1.51	-	-	-	-	
		Sones	14.4	14.6	14.9	15.7	17.1	18.2	21	-	-	-	-	
3825	1796	RPM	504	544	584	623	666	707	785	866	-	-	-	
		BHP	0.81	0.91	1.01	1.11	1.23	1.36	1.63	1.95	-	-	-	
		Sones	15.7	15.7	16.1	16.6	18.1	19.3	22	25	-	-	-	
4125	1937	RPM	537	575	612	648	685	726	797	873	948	-	-	
		BHP	1	1.1	1.21	1.32	1.44	1.57	1.85	2.16	2.52	-	-	
		Sones	17.7	17.9	18.2	18.4	19.2	20	23	26	29	-	-	
4325	2031	RPM	559	595	631	666	701	737	810	879	951	-	-	
		BHP	1.14	1.25	1.36	1.48	1.6	1.73	2.01	2.32	2.67	-	-	
		Sones	19.3	19.2	19.1	19.6	21	21	24	26	29	-	-	
4625	2171	RPM	593	627	660	693	726	759	830	892	959	-	-	
		BHP	1.37	1.49	1.61	1.73	1.86	1.99	2.28	2.59	2.94	-	-	
		Sones	20	21	21	22	22	23	25	27	30	-	-	
4825	2265	RPM	616	649	681	712	743	775	841	905	966	-	-	
		BHP	1.55	1.67	1.8	1.92	2.05	2.19	2.48	2.79	3.14	-	-	
		Sones	23	23	23	23	24	24	26	28	30	-	-	
5125	2406	RPM	650	681	711	741	771	800	860	925	-	-		
		BHP	1.84	1.97	2.1	2.23	2.37	2.51	2.81	3.13	-	-		
		Sones	25	25	25	25	26	26	27	29	-	-		
5325	2500	RPM	673	703	732	761	789	818	875	-	-	-		
		BHP	2.05	2.19	2.32	2.46	2.6	2.74	3.05	-	-	-		
		Sones	27	27	27	27	27	27	28	-	-	-		
5625	2641	RPM	707	736	764	791	818	845	-	-	-	-		
		BHP	2.4	2.54	2.69	2.83	2.98	3.13	-	-	-	-		
		Sones	29	29	29	29	29	29	-	-	-	-		
5825	2735	RPM	730	758	785	812	-	-	-	-	-	-		
		BHP	2.65	2.8	2.95	3.1	-	-	-	-	-	-		
		Sones	31	31	31	31	-	-	-	-	-	-		
6125	2876	RPM	765	-	-	-	-	-	-	-	-	-		
		BHP	3.07	-	-	-	-	-	-	-	-	-		
		Sones	33	-	-	-	-	-	-	-	-	-		

S&P Canada Ventilation Products, Inc., Div. of Soler & Palau Ventilation Group, certifies that the Model LSF shown herein are licensed to bear the AMCA Seal. The ratings shown are based on test and procedures performed in accordance with AMCA Publication 211 and AMCA Publication 311 and comply with the requirement of the AMCA Certified Ratings Program.



Performance certified is for installation type B: free inlet, ducted outlet. Power rating (BHP) does not include transmission losses. Performance ratings do not include the effects of appurtenances (accessories). The sound ratings shown are loudness values in fan sones at a distance of 1.5 m (5 ft) in a hemispherical free field calculated per AMCA International Standard 301. Values shown are for installation type B: ducted outlet hemispherical sone levels. Ratings do not include the effect of duct end correction.

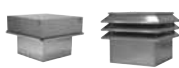

LSF 18

MODEL LSF	CFM	OV		Static Pressure in Inches w.g.												
				1/8	1/4	3/8	1/2	5/8	3/4	1	1-1/4	1-1/2	2			
2250	765	RPM	253	-	-	-	-	-	-	-	-	-	-	-	-	
		BHP	0.13	-	-	-	-	-	-	-	-	-	-	-	-	
		Sones	4.2	-	-	-	-	-	-	-	-	-	-	-	-	
2600	884	RPM	269	336	-	-	-	-	-	-	-	-	-	-	-	
		BHP	0.17	0.25	-	-	-	-	-	-	-	-	-	-	-	
		Sones	5.3	8.3	-	-	-	-	-	-	-	-	-	-	-	
2950	1003	RPM	287	348	404	-	-	-	-	-	-	-	-	-	-	
		BHP	0.23	0.31	0.41	-	-	-	-	-	-	-	-	-	-	
		Sones	6.3	6.9	8	-	-	-	-	-	-	-	-	-	-	
3300	1122	RPM	306	362	415	-	-	-	-	-	-	-	-	-	-	
		BHP	0.3	0.39	0.49	-	-	-	-	-	-	-	-	-	-	
		Sones	7.5	8	8.8	-	-	-	-	-	-	-	-	-	-	
3650	1241	RPM	326	379	427	474	-	-	-	-	-	-	-	-	-	
		BHP	0.38	0.48	0.59	0.7	-	-	-	-	-	-	-	-	-	
		Sones	8.6	9.3	9.8	10.8	-	-	-	-	-	-	-	-	-	
4000	1361	RPM	347	396	442	485	527	-	-	-	-	-	-	-	-	
		BHP	0.48	0.59	0.7	0.82	0.95	-	-	-	-	-	-	-	-	
		Sones	9.8	10.4	11.1	11.7	12.8	-	-	-	-	-	-	-	-	
4350	1480	RPM	369	415	458	499	538	-	-	-	-	-	-	-	-	
		BHP	0.59	0.71	0.83	0.96	1.09	-	-	-	-	-	-	-	-	
		Sones	11.1	11.7	12.4	12.9	13.7	-	-	-	-	-	-	-	-	
4700	1599	RPM	391	435	475	514	551	588	657	-	-	-	-	-	-	
		BHP	0.72	0.85	0.99	1.12	1.26	1.4	1.7	-	-	-	-	-	-	
		Sones	12.3	13.1	13.7	14.4	14.9	15.8	17.9	-	-	-	-	-	-	
5050	1718	RPM	414	455	493	530	565	600	667	730	-	-	-	-	-	
		BHP	0.87	1.02	1.16	1.3	1.45	1.59	1.91	2.24	-	-	-	-	-	
		Sones	13.7	14.6	15	15.8	16.3	17.1	19.1	21	-	-	-	-	-	
5400	1837	RPM	437	476	512	547	581	614	678	739	797	-	-	-	-	
		BHP	1.04	1.2	1.35	1.5	1.65	1.81	2.14	2.48	2.84	-	-	-	-	
		Sones	14.9	16	16.7	17.3	17.9	18.5	20	22	24	-	-	-	-	
5750	1956	RPM	460	497	532	565	597	629	690	749	805	912	-	-	-	
		BHP	1.24	1.4	1.57	1.73	1.89	2.05	2.39	2.75	3.12	3.9	-	-	-	
		Sones	16.6	17.5	18	18.7	19.6	20	21	23	25	29	-	-	-	
6100	2075	RPM	483	519	552	584	615	645	703	760	814	918	-	-	-	
		BHP	1.45	1.63	1.81	1.98	2.15	2.32	2.67	3.04	3.43	4.23	-	-	-	
		Sones	18	19.1	20	20	21	22	23	24	26	30	-	-	-	
6450	2194	RPM	506	541	573	603	633	662	718	772	825	925	-	-	-	
		BHP	1.69	1.89	2.07	2.25	2.43	2.61	2.98	3.36	3.76	4.59	-	-	-	
		Sones	19.7	21	21	22	23	23	24	25	27	31	-	-	-	
6800	2313	RPM	530	563	594	623	652	680	733	786	836	934	-	-	-	
		BHP	1.96	2.17	2.36	2.55	2.74	2.93	3.32	3.71	4.12	4.98	-	-	-	
		Sones	21	22	23	24	24	25	26	27	28	31	-	-	-	
7150	2432	RPM	554	586	615	644	671	698	750	800	849	943	-	-	-	
		BHP	2.26	2.47	2.68	2.88	3.08	3.28	3.68	4.1	4.52	5.4	-	-	-	
		Sones	23	24	25	26	26	26	28	28	30	32	-	-	-	
7500	2551	RPM	577	608	637	665	691	717	767	815	863	954	-	-	-	
		BHP	2.58	2.81	3.03	3.24	3.45	3.66	4.08	4.51	4.95	5.86	-	-	-	
		Sones	25	25	26	27	28	28	29	30	31	34	-	-	-	
7850	2670	RPM	601	631	659	686	711	736	785	831	877	966	-	-	-	
		BHP	2.93	3.18	3.41	3.63	3.86	4.07	4.51	4.96	5.41	6.35	-	-	-	
		Sones	26	27	28	29	29	30	31	32	33	35	-	-	-	
8200	2789	RPM	625	654	681	707	732	756	803	848	892	978	-	-	-	
		BHP	3.32	3.58	3.82	4.06	4.29	4.52	4.98	5.44	5.9	6.87	-	-	-	
		Sones	28	29	30	30	31	32	32	33	34	37	-	-	-	
8550	2908	RPM	650	678	704	729	753	776	822	866	908	992	-	-	-	
		BHP	3.74	4.01	4.27	4.51	4.76	5	5.47	5.95	6.44	7.43	-	-	-	
		Sones	30	31	32	32	33	33	34	35	36	38	-	-	-	
8900	3027	RPM	674	701	727	751	774	797	841	884	925	-	-	-	-	
		BHP	4.19	4.48	4.75	5.01	5.26	5.51	6.01	6.5	7.01	-	-	-	-	
		Sones	32	33	34	34	35	36	36	37	38	-	-	-	-	
9250	3146	RPM	698	725	749	773	796	818	861	902	942	-	-	-	-	
		BHP	4.68	4.98	5.26	5.53	5.8	6.06	6.58	7.09	7.61	-	-	-	-	
		Sones	34	35	35	36	37	37	38	39	40	-	-	-	-	
9600	3265	RPM	723	748	772	795	817	839	881	921	-	-	-	-	-	
		BHP	5.21	5.52	5.82	6.1	6.38	6.65	7.19	7.72	-	-	-	-	-	
		Sones	36	37	37	38	39	39	40	41	-	-	-	-	-	
9950	3384	RPM	747	772	795	818	839	860	901	-	-	-	-	-	-	
		BHP	5.78	6.1	6.41	6.71	7	7.28	7.84	-	-	-	-	-	-	
		Sones	38	39	39	40	40	41	43	-	-	-	-	-	-	
10300	3503	RPM	771	796	819	840	862	-	-	-	-	-	-	-	-	
		BHP	6.38	6.72	7.04	7.35	7.65	-	-	-	-	-	-	-	-	-
		Sones	40	40	41	42	43	-	-	-	-	-	-	-	-	-
10650	3622	RPM	796	820	842	-	-	-	-	-	-	-	-	-	-	
		BHP	7.03	7.38	7.72	-	-	-	-	-	-	-	-	-	-	-
		Sones	42	43	44	-	-	-	-	-	-	-	-	-	-	-

18



S&P Canada Ventilation Products, Inc., Div. of Soler & Palau Ventilation Group, certifies that the Model LSF shown herein are licensed to bear the AMCA Seal. The ratings shown are based on test and procedures performed in accordance with AMCA Publication 211 and AMCA Publication 311 and comply with the requirement of the AMCA Certified Ratings Program.



UL STANDARD 705

Performance certified is for installation type B: free inlet, ducted outlet. Power rating (BHP) does not include transmission losses. Performance ratings do not include the effects of appurtenances (accessories). The sound ratings shown are loudness values in fan sones at a distance of 1.5 m (5 ft) in a hemispherical free field calculated per AMCA International Standard 301. Values shown are for installation type B: ducted outlet hemispherical sone levels. Ratings do not include the effect of duct end correction.

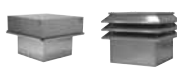

LSF 20

MODEL LSF	CFM	OV		Static Pressure in Inches w.g.														
				1/8	1/4	3/8	1/2	5/8	3/4	1	1-1/4	1-1/2	2					
20	2800	698	RPM	222	-	-	-	-	-	-	-	-	-	-	-	-		
			BHP	0.15	-	-	-	-	-	-	-	-	-	-	-	-	-	
			Sones	3.5	-	-	-	-	-	-	-	-	-	-	-	-	-	-
	3340	833	RPM	239	297	350	-	-	-	-	-	-	-	-	-	-	-	
			BHP	0.21	0.31	0.42	-	-	-	-	-	-	-	-	-	-	-	-
			Sones	4.6	5.8	7.2	-	-	-	-	-	-	-	-	-	-	-	-
	3880	968	RPM	259	312	359	405	-	-	-	-	-	-	-	-	-	-	
			BHP	0.3	0.4	0.53	0.66	-	-	-	-	-	-	-	-	-	-	-
			Sones	5.8	6.8	7.8	9.3	-	-	-	-	-	-	-	-	-	-	-
	4420	1102	RPM	282	328	372	414	454	-	-	-	-	-	-	-	-	-	
			BHP	0.41	0.52	0.65	0.79	0.94	-	-	-	-	-	-	-	-	-	-
			Sones	7.1	7.8	8.8	10	11.9	-	-	-	-	-	-	-	-	-	-
	4960	1237	RPM	306	346	388	425	463	499	-	-	-	-	-	-	-	-	
			BHP	0.55	0.67	0.8	0.95	1.11	1.28	-	-	-	-	-	-	-	-	-
			Sones	8.6	8.9	9.9	10.9	12.7	14.6	-	-	-	-	-	-	-	-	-
	5500	1372	RPM	332	367	405	441	475	509	572	-	-	-	-	-	-	-	
			BHP	0.72	0.84	0.99	1.15	1.31	1.49	1.86	-	-	-	-	-	-	-	-
			Sones	10.1	10.3	11.2	12.5	13.9	15.7	19	-	-	-	-	-	-	-	-
	6040	1506	RPM	358	390	423	457	490	520	581	638	-	-	-	-	-	-	
			BHP	0.93	1.06	1.21	1.37	1.55	1.74	2.13	2.54	-	-	-	-	-	-	-
			Sones	11.8	11.9	12.6	13.9	15.5	16.8	19.7	22	-	-	-	-	-	-	-
6580	1641	RPM	384	414	443	474	506	535	592	647	699	-	-	-	-	-		
		BHP	1.17	1.31	1.47	1.64	1.82	2.02	2.43	2.86	3.31	-	-	-	-	-	-	
		Sones	13.6	13.8	14.3	15.5	16.9	18.4	21	23	26	-	-	-	-	-	-	
7120	1776	RPM	412	438	466	493	523	552	604	657	707	800	-	-	-	-		
		BHP	1.46	1.61	1.77	1.95	2.14	2.34	2.77	3.22	3.7	4.68	-	-	-	-	-	
		Sones	15.9	15.7	16.2	17.1	18.6	20	22	24	26	32	-	-	-	-	-	
7660	1910	RPM	439	464	489	514	540	568	620	669	717	808	-	-	-	-		
		BHP	1.8	1.95	2.12	2.3	2.5	2.71	3.15	3.62	4.12	5.16	-	-	-	-	-	
		Sones	18.5	18.1	18.3	19.3	20	22	24	25	27	33	-	-	-	-	-	
8200	2045	RPM	467	489	513	537	561	585	637	682	728	816	-	-	-	-		
		BHP	2.19	2.35	2.52	2.71	2.91	3.12	3.58	4.07	4.59	5.67	-	-	-	-	-	
		Sones	21	21	21	22	22	23	25	26	28	34	-	-	-	-	-	
8740	2180	RPM	495	516	538	560	582	605	653	699	741	826	-	-	-	-		
		BHP	2.62	2.79	2.97	3.17	3.38	3.59	4.06	4.57	5.1	6.23	-	-	-	-	-	
		Sones	24	24	24	24	24	25	26	28	30	35	-	-	-	-	-	
9280	2314	RPM	523	542	563	584	605	626	670	715	756	837	-	-	-	-		
		BHP	3.12	3.3	3.48	3.69	3.9	4.12	4.61	5.12	5.67	6.84	-	-	-	-	-	
		Sones	28	27	26	26	26	26	28	30	32	36	-	-	-	-	-	
9820	2449	RPM	551	569	589	608	628	648	688	731	773	849	-	-	-	-		
		BHP	3.68	3.86	4.05	4.26	4.48	4.71	5.21	5.74	6.3	7.5	-	-	-	-	-	
		Sones	30	29	29	28	28	28	29	31	34	38	-	-	-	-	-	
10360	2584	RPM	579	597	615	633	652	671	709	748	789	-	-	-	-	-		
		BHP	4.3	4.49	4.69	4.9	5.13	5.37	5.87	6.42	6.99	-	-	-	-	-	-	
		Sones	33	32	31	31	30	30	31	33	35	-	-	-	-	-	-	
10900	2718	RPM	607	624	641	659	676	694	730	767	805	-	-	-	-	-		
		BHP	4.98	5.18	5.39	5.61	5.85	6.09	6.61	7.16	7.75	-	-	-	-	-	-	
		Sones	36	35	34	33	33	33	33	35	37	-	-	-	-	-	-	
11440	2853	RPM	636	652	668	685	701	718	752	-	-	-	-	-	-	-		
		BHP	5.74	5.95	6.16	6.39	6.63	6.88	7.41	-	-	-	-	-	-	-	-	
		Sones	39	37	36	36	35	35	35	-	-	-	-	-	-	-	-	
11980	2988	RPM	664	680	695	711	727	743	-	-	-	-	-	-	-	-		
		BHP	6.57	6.79	7.01	7.25	7.49	7.75	-	-	-	-	-	-	-	-	-	
		Sones	42	40	39	39	38	38	-	-	-	-	-	-	-	-	-	
12520	3122	RPM	693	708	-	-	-	-	-	-	-	-	-	-	-	-		
		BHP	7.48	7.7	-	-	-	-	-	-	-	-	-	-	-	-	-	
		Sones	45	43	-	-	-	-	-	-	-	-	-	-	-	-	-	



S&P Canada Ventilation Products, Inc., Div. of Soler & Palau Ventilation Group, certifies that the Model LSF shown herein are licensed to bear the AMCA Seal. The ratings shown are based on test and procedures performed in accordance with AMCA Publication 211 and AMCA Publication 311 and comply with the requirement of the AMCA Certified Ratings Program.



UL STANDARD 705

Performance certified is for installation type B: free inlet, ducted outlet. Power rating (BHP) does not include transmission losses. Performance ratings do not include the effects of appurtenances (accessories). The sound ratings shown are loudness values in fan sones at a distance of 1.5 m (5 ft) in a hemispherical free field calculated per AMCA International Standard 301. Values shown are for installation type B: ducted outlet hemispherical sone levels. Ratings do not include the effect of duct end correction.

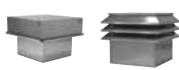

DIMENSIONS

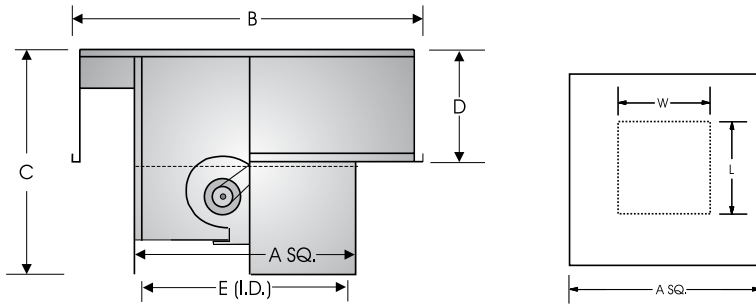

CSF Discharge Opening

Model Size	A Housing OD	B Overall Width	C Overall Height	D Intake Height	Roof Opening	E Curb Cap ID	Damper OD	Discharge Opening	Filter Size/No.	No. Tiers	Avg. Ship Weight (lbs.)
CSF-9	24 -1/2	37-1/2	23-1/2	16	19-1/2	24 X 24	16	12 X 10-1/2	16 X 20 X 1 (4)	N/A	265
CSF-10	28-1/2	43	23-1/2	16	23-1/2	28 X 28	20	13-1/4 X 11-5/8	16 X 25 X 1 (4)	N/A	290
CSF-12	28-1/2	43	30-1/2	16	23-1/2	28 X 28	20	15-7/8 X 13-5/8	16 X 25 X 1 (4)	N/A	340
CSF-15	32-1/2	50-1/2	32	16	27-1/2	32 X 32	24	18-7/8 X 16-1/4	16 X 25 X 1 (4)	N/A	380
CSF-18	36-1/2	56-1/2	38-1/2	22	31-3/8	36 X 36	27	22-1/4 X 19	20 X 25 X 1 (4)	N/A	540
CSF-20	51-1/4	74-1/2	46-3/4	26	46	51 X 51	42	23-1/8 X 25	20 X 25 X 1 (8)	N/A	890

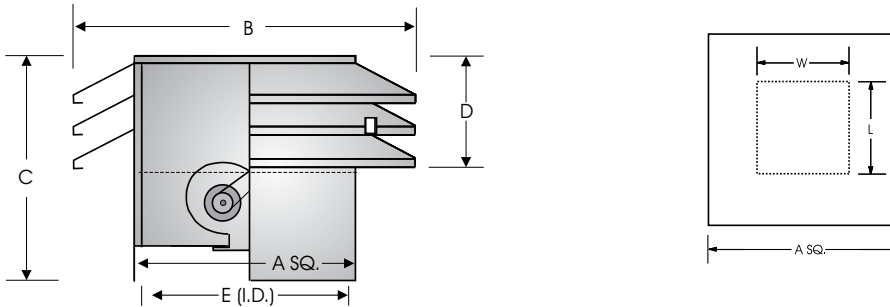

LSF Discharge Opening

Model Size	A Housing OD	B Overall Width	C Overall Height	D Intake Height	Roof Opening	E Curb Cap ID	Damper OD	Discharge Opening	Filter Size/No.	No. Tiers	Avg. Ship Weight (lbs.)
LSF-9	24 -1/2	37-3/4	23-3/4	16-1/8	19-1/2	24 X 24	16	12 X 10-1/2	16 X 20 X 1 (4)	3	265
LSF-10	28-1/2	41-3/4	23-3/4	16	23-1/2	28 X 28	20	13-1/4 X 11-5/8	16 X 25 X 1 (4)	3	290
LSF-12	28-1/2	41-3/4	30-1/2	16	23-1/2	28 X 28	20	15-7/8 X 13-5/8	16 X 25 X 1 (4)	3	340
LSF-15	32-1/2	45-3/4	32	18	27-1/2	32 X 32	24	18-7/8 X 16-1/4	21-1/2 X 28 X 1 (4)	4	380
LSF-18	36-1/2	50	38-5/8	23	31-3/8	36 X 36	27	22-1/4 X 19	24 X 30 X 1 (4)	5	540
LSF-20	51-1/2	65	47	26	46	51 X 51	42	23-1/8 X 25	25-1/2 X 45-1/2 X (4)	5	890

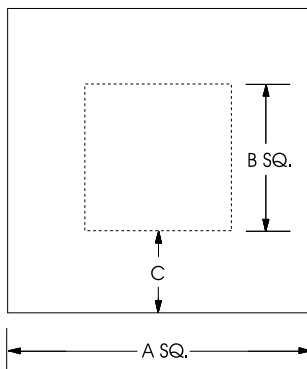

Duct Adaptor Dimensions

Model/Size CSF/LSF	A SQ.	B SQ.	C
CSF/LSF-9	18-1/2	14-1/2	2
CSF/LSF-10	22-1/2	18-1/2	2
CSF/LSF-12	22-1/2	18-1/2	2
CSF/LSF-15	26-1/2	20-1/2	3
CSF/LSF-18	30-1/2	24-1/2	3
CSF/LSF-20	45	30	7-1/2